

**KENT**  
Ultra Violet  
Water Purifiers  
HOUSE of PURITY



Marketed by:  
KENT RO SYSTEMS LTD.  
E-6, 7 & 8, Sector-59, Noida, U.P.-201 309, India.  
E-mail: sales@kent.co.in | Website: www.kent.co.in

Manufactured by:  
KENT RO SYSTEMS LTD.  
1. Khasra No. 93, Village-Bantakhedi, Tehsil-Roorkee,  
District-Haridwar, Uttarakhand-247 668, India.

2. A-6, Sector-87, Noida-201305, U.P., India.
3. A-7, Sector-87, Noida-201305, U.P., India.

For customer complaints, contact Customer Care officer at:  
E-6, 7 & 8, Sector-59, Noida, U.P.-201 309, India. Call: 92-789-12345  
E-mail: service@kent.co.in or Visit us at www.kent.co.in

**KENT**  
**SMART UV**  
Online UV Water Purifier



**Instruction handbook  
for Installation, Operation  
and Maintenance.**



**KENT**  
Ultra Violet  
Water Purifiers  
HOUSE of PURITY

4 Stage Smart  
UV Water Purifier

## Welcome to KENT

Dear Customer,

At the outset, allow us to thank you for your trust in **KENT** water purifiers. We take pride in our reputation for product quality and industry proven performance. We are certain that your decision to own **KENT SMART UV** water purifier will go a long way towards keeping you and your family in good health. We are confident that you will be satisfied with its performance and that it will serve your need for safe and clean drinking water.

This guide will help you get the best out of your water purifier. Please go through this booklet to familiarize yourself with its operation and maintenance.

You can look forward to years of trouble free service. contact your nearest KENT dealer or branch.

**Best Wishes**

**KENT RO SYSTEMS LTD.**

## Table of Contents

1. Introduction .....	1
2. Your Water Purifier and its Parts .....	1
3. Important Instructions .....	2
4. A look at the UV Process .....	3
5. Stages of Water Treatment .....	3
6. UV Fail Alarm .....	3
7. Purification Flow Chart .....	4
8. Electrical Circuit Diagram .....	4
9. Installation Instructions .....	5
10. Starting-up the Purifier .....	7
11. Technical Specifications .....	7
12. Maintenance Tips .....	8

## Introduction

Presenting the **KENT SMART UV** water purifier; Its Ultra Violet (UV) purification technology is highly effective in killing bacteria & viruses and also reduces all kinds of residual impurities ensuring safe drinking water.

**a) KENT SMART UV** water purifier comes with the following modern features:

- Effective against bacteria, viruses and all kinds of residual impurities including chlorine.
- User-friendly and environmentally safe. Its easy-to-handle process is devoid of any dangerous chemicals or risks factors of overdosing.
- Completely disinfects water without changing its taste, odour and pH scale. With constant conductivity, the general chemistry of water is not hampered.
- Easy to install, all that it requires is a water connection and a power supply.

**b) How is KENT SMART UV** better than other UV based purifiers:

- Wall mountable - best suited for Indian homes and offices.
- ABS construction for corrosion free use
- Carbon Block Filter Technology- for added protection from bacteria.
- Incorporates UV fail alarm which beeps if UV Lamp is not functional.

## Your Water Purifier and its Parts

Please check the following items in the packaged box:

- |  |   |            |
|--|---|------------|
| 1. <b>KENT SMART UV</b> Water Purifier | : | 1 N        |
| 2. 3-Way Connector                     | : | 1 N        |
| 3. S.S. Ball Valve                     | : | 1 N        |
| 4. Food Grade Pipe 0.635 Cm (White)    | : | 2.5 Meters |
| 5. Warranty Card                       | : | 1 N        |
| 6. Screws & Plastic Inserts            | : | 2 N each   |
| 7. Sticker Center Drill                | : | 1 N        |

## Important Instructions

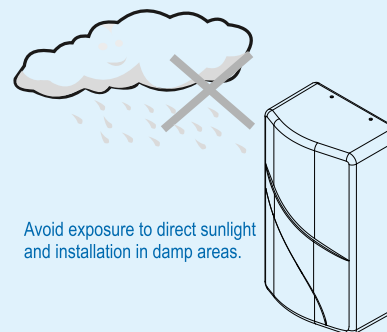

Avoid exposure to direct sunlight and installation in damp areas.

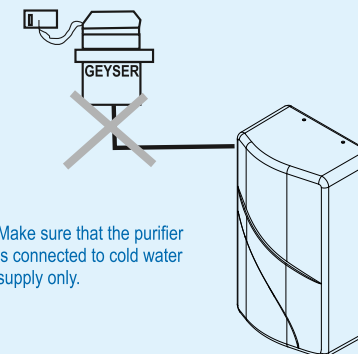

Make sure that the purifier is connected to cold water supply only.



Use Genuine Kent spares for optimum performance

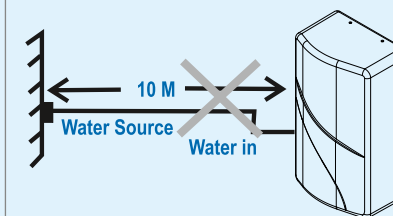

The maximum distance between the raw water source and the purifier should not be more than 3 meters.

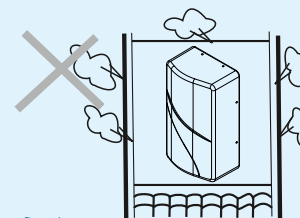

Do not confine the purifier in any kind of cabinet.

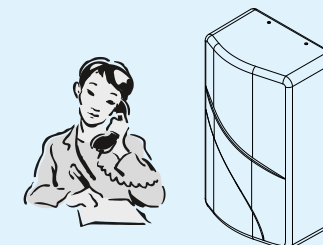

Do not try to service the product on your own. Instead, call service technician for help.

## A look at the UV Process

The UV light has shorter wavelength as electromagnetic radiation. UV-C rays (photons) penetrate into micro-organisms and directly get absorbed in the DNA content of the pathogen. Finally, the DNA is modified in such a way that it stops further reproduction of the organism.

UVB  
280-315 UVA  
UVC  
200-280 315-400  
400 700  
Wavelength (nm)

X-Rays Ultraviolet Visible Infrared Microwaves Radio

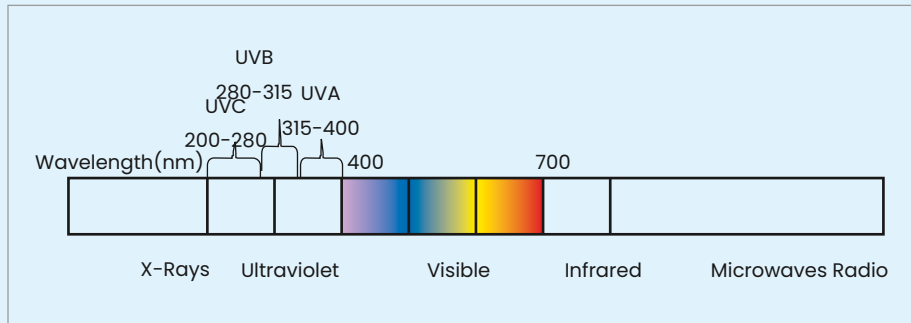

## Stages of Water Treatment

Following are the stages of water treatment:

- Stage 1 : Inline Sediment
- Stage 2 : Inline Carbon
- Stage 3 : UV Chamber
- Stage 4 : Post Carbon

## UV Fail Alarm

KENT Smart UV has an inbuilt alarm that goes on when the UV Lamp stops drawing sufficient current from the power source. With the help of this unique feature, the user knows whether the UV Lamp is working properly or not. In such circumstances, kindly switch off the purifier and call service technician for help.

## Purification Flow Chart

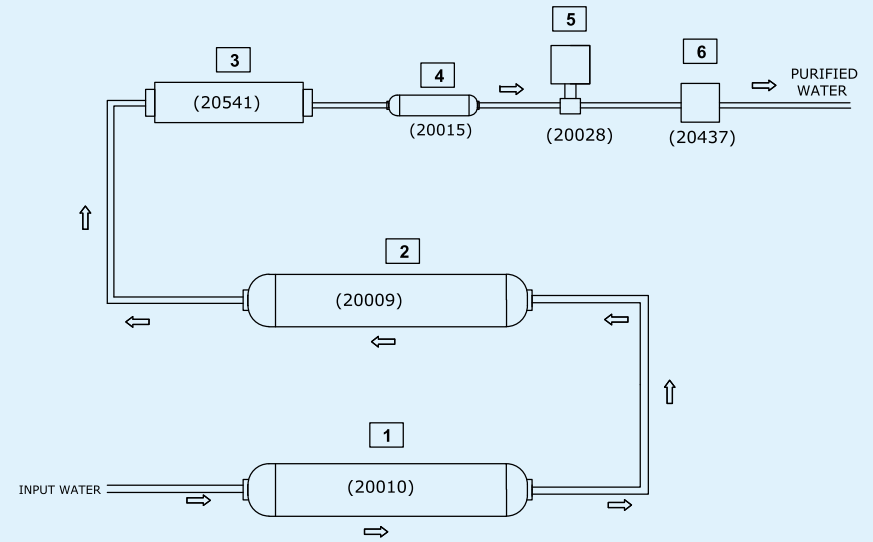

S.NO.	SPARE PART CODE	ITEM DESCRIPTION
1	20010	SEDIMENT FILTER
2	20009	ACTIVATED CARBON FILTER
3	20541	UV CHAMBER
4	20015	POST CARBON FILTER
5	20028	SOLENOID VALVE
6	20437	TDS CONTROL VALVE ULTRA

## Electrical Circuit Diagram

S.NO.	SPARE PART CODE	ITEM DESCRIPTION
1	20024	SMPS / BALLAST
2	20028	SOLENOID VALVE
3	20541	UV CHAMBER
4	20540	UV LAMP

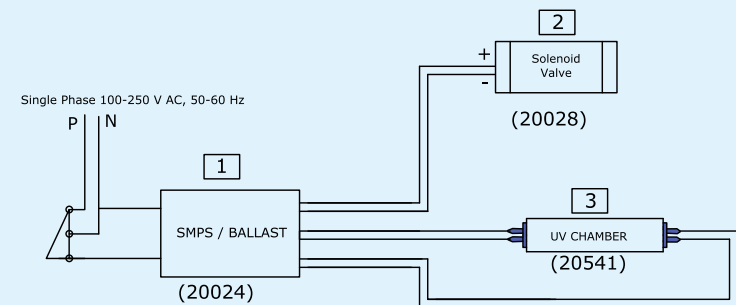

## Installation Instructions

The KENT **SMART UV** Purifier is a product of advanced technology that ensures safe and clean drinking water. The purifier is easy and convenient to install.

### Recommended Site Preparations :

- Single phase 140-250 V AC, 50-60 Hz, connection not more than 3 meters away from the point of installation.
- Raw water supply with ½ inch nipple, not more than 3 meters away from the point of installation.
- Space as per dimensions of the purifier.
- Wall/plane surface for mounting two screws and holding the water purifier.
- The system and installation must comply with applicable state and local laws & regulation.

### Special Instructions:

1. KENT Smart UV is a wall mountable purifier. Make sure that it is only mounted on a wall. Avoid installation on wooden and metallic stands.
2. It is preferable to install the purifier near a sink so that raw water supply is easily available.

### Installation Procedure:

1. Screw in the two 10x50 self tapping screws (supplied with the package) on a same horizontal level at a distance of 120 mm from each other in the wall.
2. Carefully hang the purifier on the wall with the help of wall mounting slots present on the back side of the purifier as shown in the figure below.

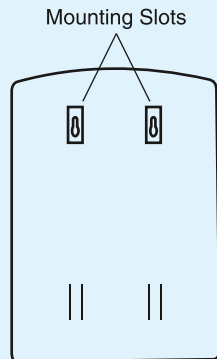

3. Fix the SS ball valve to the ¼ inch port of the 3-way connector as shown in the figure.

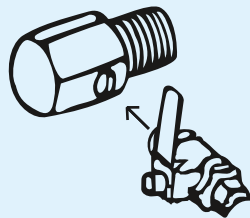

5

4. Connect the 3-way connector to the raw water supply as shown in the figure. The threaded end of the 3-way connector is fitted in line with the raw water supply. The other end can be connected to a tap or can be plugged off if not required.

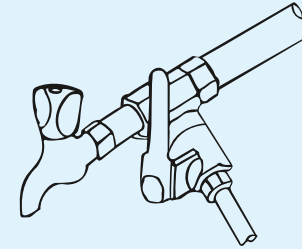

5. Connect one end of the white pipe to the SS ball valve and other end to the lower hex connector on the left hand side of the purifier, which is labeled as WATER IN with the help of connector nuts.

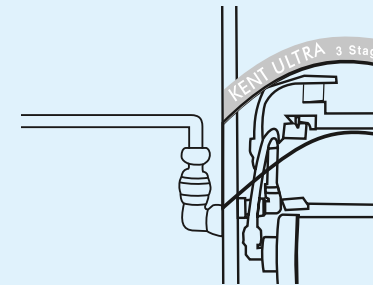

6. Before connecting the electric supply, it is important that you perform the following functions:
  - (i) Open the SS ball valve (Handle parallel to the ball valve) to start the flow of water into the purifier.

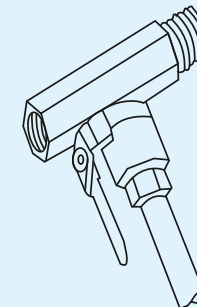

- (ii) Wait for 2-3 minutes to ensure that the two pre-filters are soaked in water.

6

## Starting-up the Purifier

1. Remove the front cover of the water purifier.
2. Switch on the electrical supply and the power switch of the water purifier.
3. Check the flow rate of the purified water. For effectiveness of the UV treatment, the flow rate of the purified water should not be more than 1 LPM. Adjust the flow rate of the purified water by adjusting the needle control valve.
4. Once the desired flow rate is achieved, switch off the power supply and put back the front cover.
5. The purifier is now ready for use.

## Technical Specifications

Product	KENT SMART UV
Product Code	111143
Product Generic Name	Water Purifier
Product Colour	Black
Body Material	ABS
Mounting	Wall Mounting
Dimensions (mm)	240 (L) x 150 (W) x 400 (H)
Purification Production Rate	60 L/hr. (Depending on Inlet Water Pressure)
Inlet Water Pressure/Temp (min.)	0.3 kg. / cm <sup>2</sup> / 10°C
Inlet Water Pressure/Temp (max.)	4.0 kg. / cm <sup>2</sup> / 40°C
UV Lamp Wattage	11 W
Life of UV Lamp	5000 hrs. of operation
Total Power Consumption	36 W
Input Power Supply	Single Phase 140-250 V AC, 50-60 Hz. 
Net Weight	3.05 kg.

## Maintenance Tips

To ensure that the purifier operates at its optimum level, a routine maintenance must be performed. The frequency of the maintenance will greatly depend on raw water quality and consumption of purified water.

- Replace sediment and activated carbon filter after every 12 months, depending on the raw water quality and consumption.
- UV Lamp should be replaced once a year.
- If the purifier is not going to be used for a long time (in case you are on a holiday, tour or out of home), make sure that you disconnect the power supply and turn off the raw water supply.

Note : Filters are consumables. Their replacement time is dependent on the quality of raw water and water consumption. They are not covered under the warranty. However, if the filters choke within 6 months, they will be cleaned / repaired / replaced free of cost. Changing the filter and system inspection is available on call.